

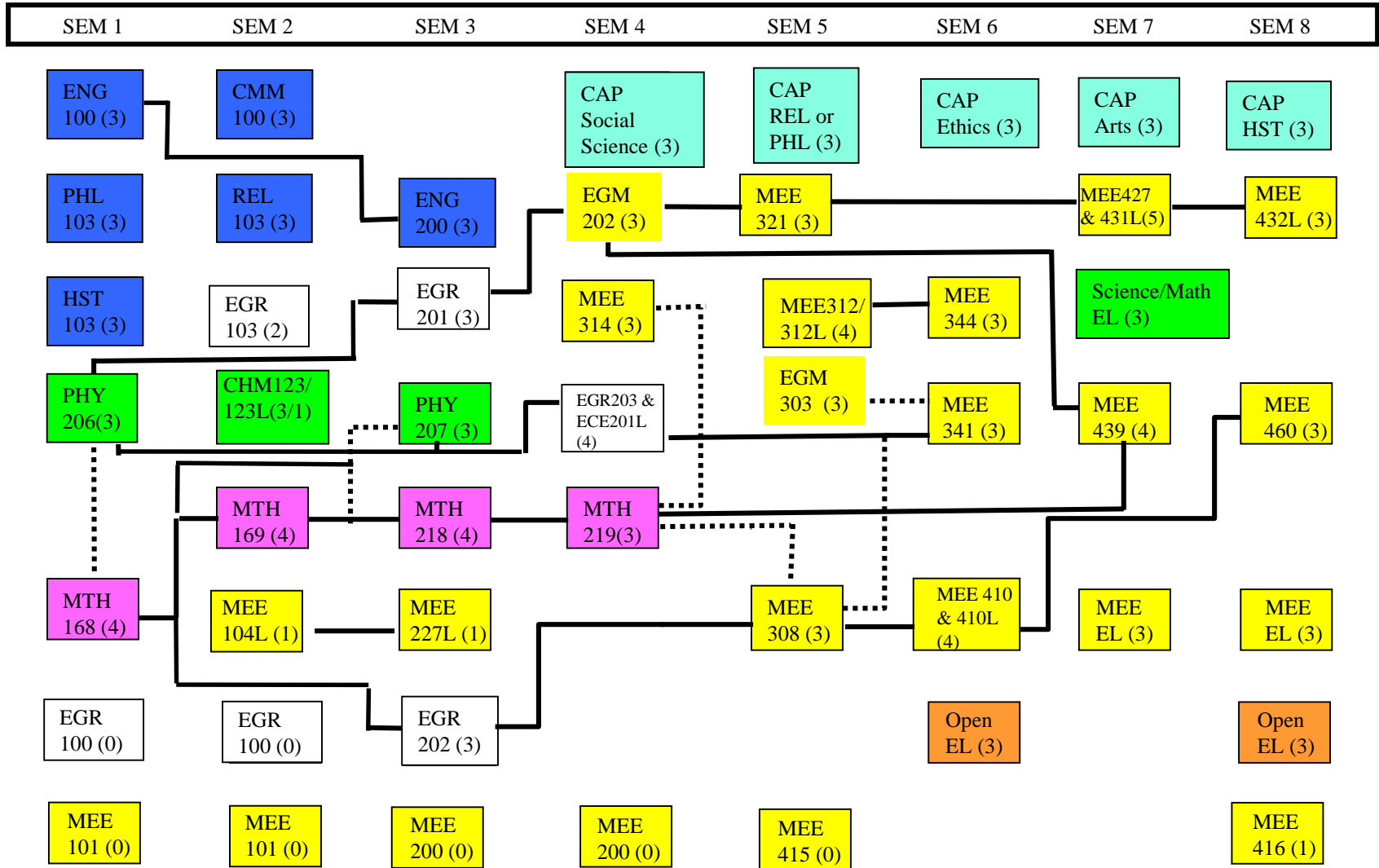









BACHELOR OF MECHANICAL ENGINEERING 2014



 CAP Base	 Science	 MEE course	 Corequisite	* PHY210L can be taken instead. If so, switch PHY206 and CHM123.
 Common Academic Program (CAP)	 Math	 Open elective	 Prerequisite	
 Integrated Engineering Core				