

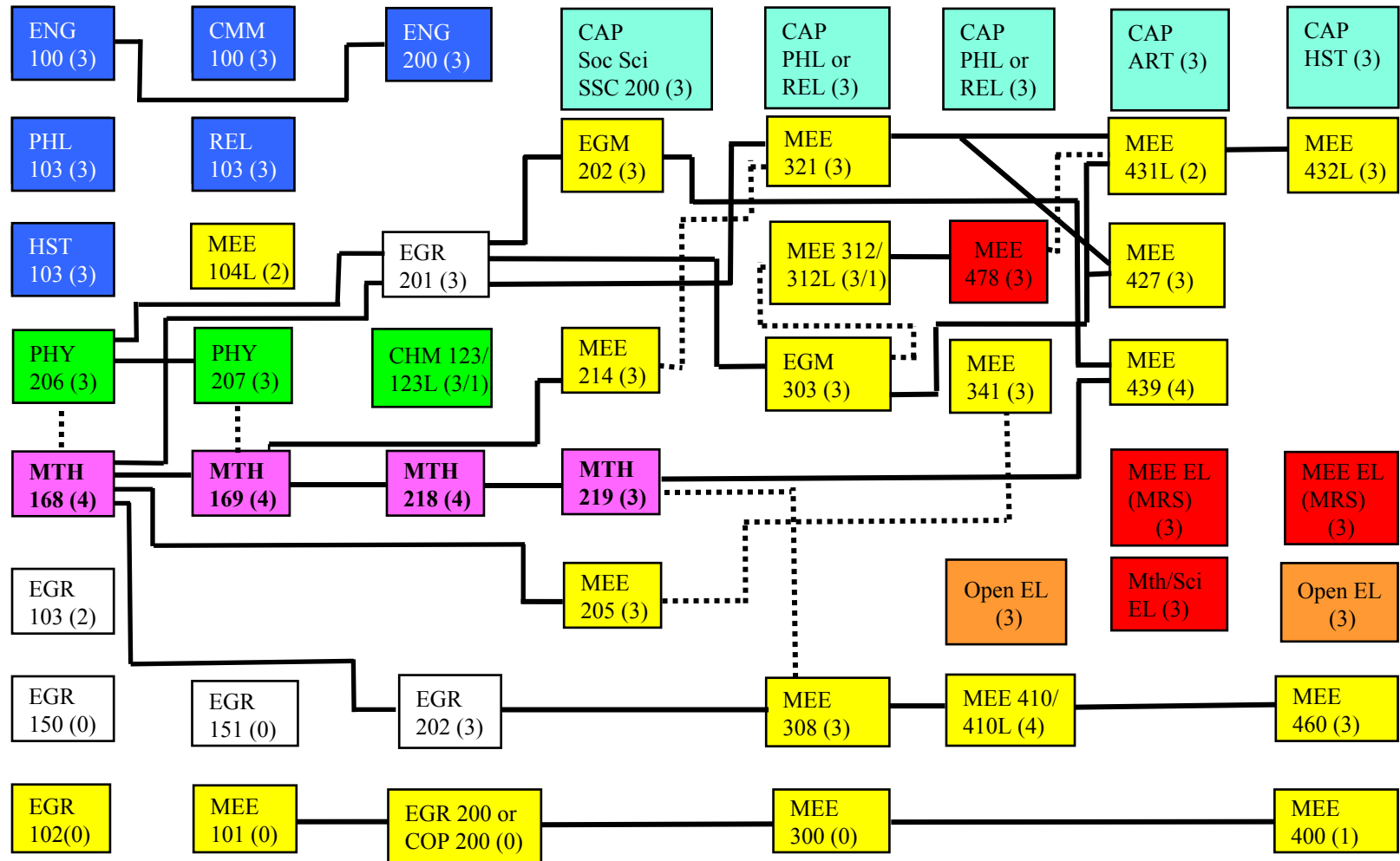









# BACHELOR OF MECHANICAL ENGINEERING – Energy Systems-Mechanical Concentration (MRS) 2019

**SEM 1 18CR    SEM 2 15CR    SEM 3 17CR    SEM 4 15CR    SEM 5 16CR    SEM 6 16CR    SEM 7 18CR    SEM 8 16CR**



 CAP Base	 Science	 MEE course	 Corequisite	* Selected MRS Energy courses have the potential to count towards Open Elective, CAP OR Mth/Sci Elective
 Math	 Open elective	 MRS	 Prerequisite	
 Common Academic Program (CAP)	 Integrated Engineering Core			