

BACHELOR OF MECHANICAL ENGINEERING – Aerospace Concentration 2019

SEM 1 18CR SEM 2 15CR SEM 3 16CR SEM 4 16CR SEM 5 18CR SEM 6 17CR SEM 7 14CR SEM 8 17CR

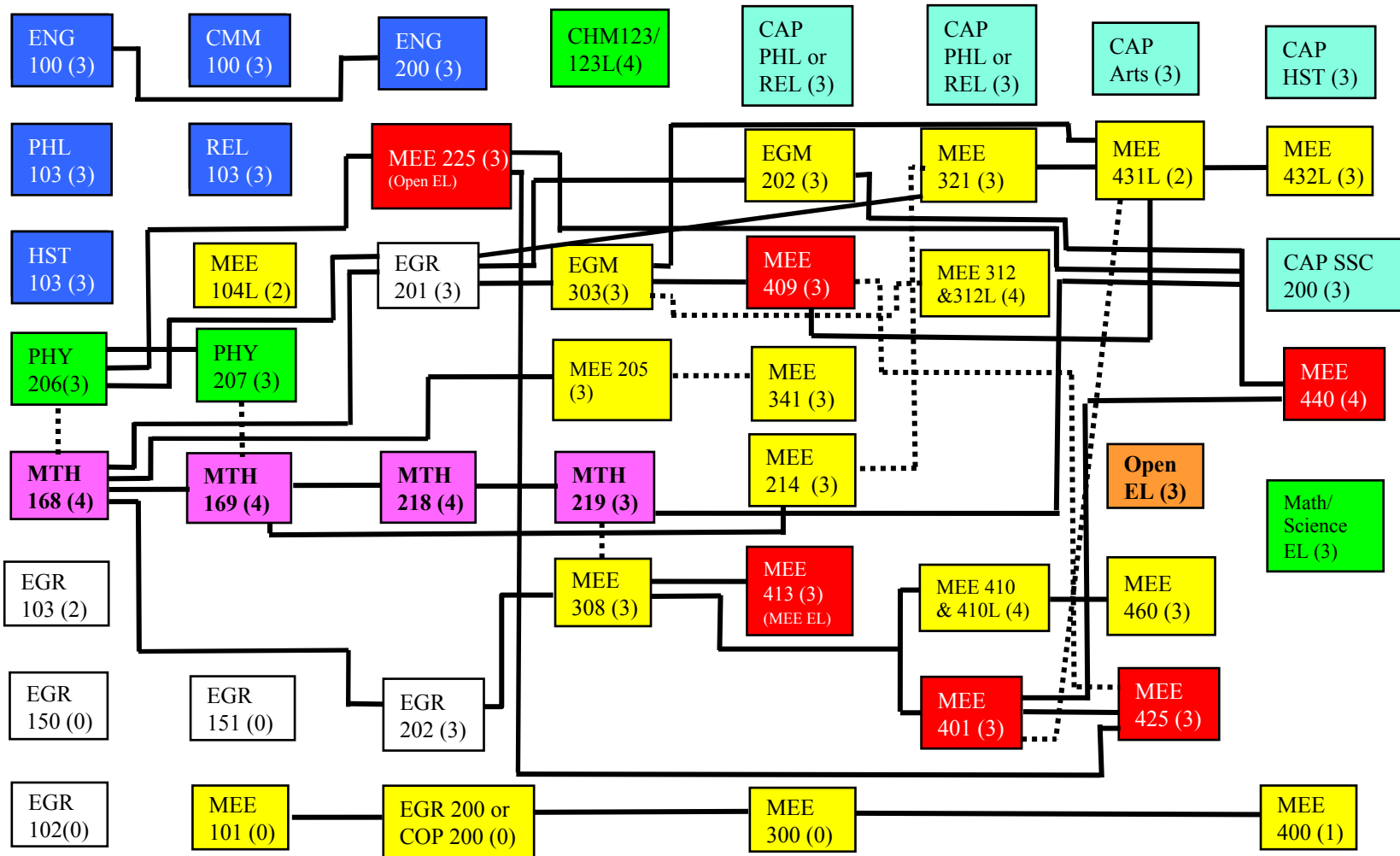

 CAP Base	 Science	 MEE course Corequisite	* PHY210L can be taken instead. If so, switch PHY206 and CHM123.
 Aerospace	 Math	 Open elective	— Prerequisite	
 Common Academic Program (CAP)	 Integrated Engineering Core			