

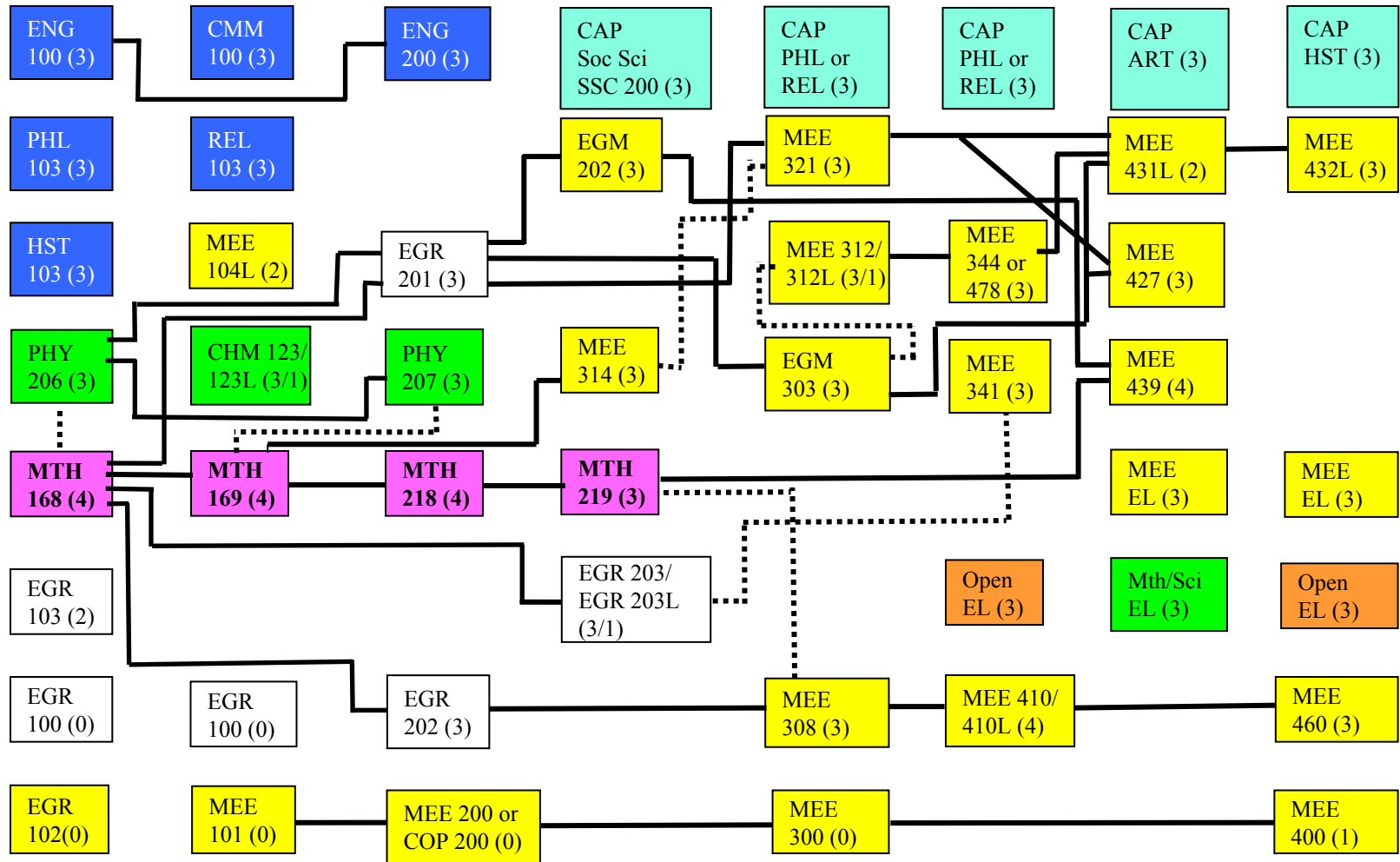









BACHELOR OF MECHANICAL ENGINEERING 2017

SEM 1 18CR SEM 2 16CR SEM 3 16CR SEM 4 16CR SEM 5 16CR SEM 6 16CR SEM 7 18CR SEM 8 16CR



 CAP Base	 Science	 MEE course	 Corequisite	* PHY210L can be taken instead. If so, switch PHY206 and CHM123.
 Common Academic Program (CAP)	 Math	 Open elective	 Prerequisite	
	 Integrated Engineering Core			